

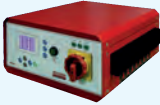











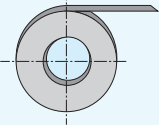













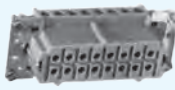

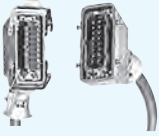



TEMPERATUR-REGELGERÄTE
TEMPERATURE CONTROLLERS

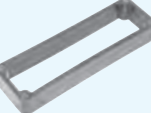

STRACK®
NORMALIEN

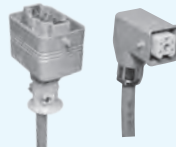
						
Z 7500	Z 7510	Z 7520	Z 7530 GC	Z 7538 RE-14	Z 7556 B	
deutsch	4	8	10	12	14	15
english	16	20	22	24	26	27
						
Z 7393	Z 7394	Z 7395	Z 7395HT	Z 7401	Z 7402	
28	28	28	28	29	29	
						
Z 7403	Z 7405	Z 7406	Z 7407	Z 7408	Z 7409	
29	29	30	30	30	30	
						
Z 7410	Z 7411	Z 7415	Z 7416	Z 7419H	Z 7421H	
31	31	31	32	32	32	
						
Z 7423	Z 7424	Z 7425	Z 7427	Z 7429	Z 7429L	
33	33	34	34	35	35	
						
Z 7433	Z 7440	Z 7442	Z 7443	Z 7444H	Z 7445	
36	37	37	37	38	38	
						
Z 7446						
38						

Temperatur-Regelgeräte

Temperature controllers

Technische Daten

Betriebsspannung	230 V, 48...63 Hz
Leistungsstellbereich	1...100 %
Temperaturregler-Einschub	19''
Temperatur-Bereich	bis 450 °C (500 °C)

Technical data

Operating voltage	230 V, 48...63 Hz
Power setting range	1...100 %
Temperature controller-module	19''
Temperature range	till 450 °C (500 °C)

Mehrzonentemperaturregler Multizones temperature controllers

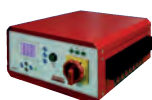

Temperaturregler Temperature controller



Regler-Einschübe Controller modules





Bezeichnung	Designation	Z 7500	Z 7510	Z 7520	Z 7538 RE-14
Leistung / Zone	Performance / Zone	3,60 kW/16 A	3,60 kW/16 A	2,3 kW/10 A	2,85 kW/12,5 A
Automatische Umschaltung bei Fühlerbruch auf Leistungsmittelwert	Automatic switching at thermo coupler break on average power value	<input type="checkbox"/>	<input type="checkbox"/>		<input type="checkbox"/>
Manuelles Umschalten auf Stellgrad	Manual switching on regulation ratio	<input type="checkbox"/>	<input type="checkbox"/>	<input type="checkbox"/>	<input type="checkbox"/>
Mehrere Düsen getrennt regelbar	Several nozzles can be controlled separately	10, 12, 16	4, 6, 8	1, 2	
Boost-Funktion	Boost function	<input type="checkbox"/>	<input type="checkbox"/>		<input type="checkbox"/>
Eignung für thermisch empfindliche Kunststoffe	Suitable for plastics being sensitive with regard to temperature	<input type="checkbox"/>	<input type="checkbox"/>	<input type="checkbox"/>	<input type="checkbox"/>
Anfahrerschutz durch Leistungsbegrenzung beim Aufheizen	Startup protection by power limitation during heating up	<input type="checkbox"/>	<input type="checkbox"/>	<input type="checkbox"/>	<input type="checkbox"/>
Digitale Soll- und Istwert-Anzeige	Digital set point- and actual value display	<input type="checkbox"/>	<input type="checkbox"/>	<input type="checkbox"/>	<input type="checkbox"/>
Automatisches Absenken der Temperatur bei Maschinenstillstand	Automatic reduction of temperature at machine standstill	<input type="checkbox"/>	<input type="checkbox"/>		<input type="checkbox"/>
Verbundaufheizung	Even heat up mode	<input type="checkbox"/>	<input type="checkbox"/>		
Regelverhalten selbstoptimierend	Control behavior self-optimizing	<input type="checkbox"/>	<input type="checkbox"/>	<input type="checkbox"/>	<input type="checkbox"/>
Temperatur-Grenzwerte frei wählbar (Grenzwertüberwachung)	Temperature limit values can be freely selected (limit value monitoring)	<input type="checkbox"/>	<input type="checkbox"/>	<input type="checkbox"/>	<input type="checkbox"/>
Fühlerverpolungsschutz	Thermo couple polarity protection	<input type="checkbox"/>	<input type="checkbox"/>	<input type="checkbox"/>	<input type="checkbox"/>
Triacüberwachung	Triac supervision	<input type="checkbox"/>			<input type="checkbox"/>
Schnittstelle RS 232, RS 485 (optional)	Interface RS 232,RS 485 (optional)	<input type="checkbox"/>	<input type="checkbox"/>		
Maschinenschnittstelle (optional)	Machine interface (optional)	<input type="checkbox"/>			
Werkzeugdiagnose	Tool diagnosis	<input type="checkbox"/>			
Grundeinheit Z 7530 GC	Basic unit Z 7530 GC				<input checked="" type="checkbox"/>

Mehrzonen Temperaturregler Z 7500



Type 16

Z 7500		Type	Zonen/ max. Last	Leistung gesamt	Netz 3 x 230/400	Abmessungen B x H x T mm
 Z 7500-Type		10	10 x 16 A	17,25 kW	3 x 25 A	429 x 167 x 380
		12	12 x 16 A	17,25 kW	3 x 25 A	429 x 167 x 380
		16	16 x 16 A	17,25 kW	3 x 25 A	429 x 167 x 380

Kompaktregler für alle 230 V Heißkanal-systeme mit 10-16 Heizzonen

Vorteile

- komfortable Bedienung
- übersichtliche Anzeigen
- kompakte Bauform

Das speziell für den Anwendungsbereich Heißkanalregelung optimierte Konzept bietet größtmögliche Regelqualität, einfache Bedienung und umfangreiche Selbstüberwachung. Die Geräte sind unabhängig vom Werkzeughersteller einsetzbar.

Merkmale

- Kompakte Reglereinheit für 10, 12 oder 16 Zonen
- Speziell optimiert für Heißkanal-Anwendungen
- Komfortable, ergonomische Bedienung mit Klartextanzeige

Regelelektronik und Halbleiter-Schalt-elemente vereint in einem kompakten, stabilen Metallgehäuse. Bedientaster und rastende Schalter auf der Gerätefront zur komfortablen Bedienung und Überwachung aller Heizzonen. Seitlich außen angebrachte Lastsicherungen ermöglichen unkomplizierten Sicherungswechsel im Fehlerfall.

- Automatische Regelstrecken-anpassung jeder Zone
- Integrierte Laststromkontrolle
- Zahlreiche, einstellbare Heißkanalfunktionen
- Werkzeugdiagnose serienmäßig

Mikroprozessorregler mit automatischer Regelstrecken-anpassung für optimale Regelqualität an flinken Düsenheizungen wie an trägen Verteilerstrecken. Zahlreiche Regelparameter sind anwendungsspezifisch einstellbar, daher kann der Regler auch an komplexen und schwierigen Werkzeugen präzise betrieben werden. Die Optimierung kann auch nachträglich im Heißbetrieb gestartet werden.

LCD-Bildschirm mit Schreiberfunktion

Der helle LCD-Bedienbildschirm erlaubt eine einfache, klar gegliederte Übersicht über alle wichtigen Funktionen und Betriebszustände.

Alternativ können alle Zonen mit IST-Temperaturen, Soll/Ist-Vergleich oder alle Detailangaben jeder einzelnen Zone dargestellt werden. Zusätzlich sind eine Trendanzeige sowie eine grafische Schreiberfunktion für den zeitlichen Verlauf der IST-Temperatur möglich.



Detailansicht Einzelzone



Schreiberfunktion Einzelzone

I S T - W E R T	1	110	2	110	3	110	4	110
	5	110	6	110	7	110	8	110
	9	110	10	110	11	110	12	110
	13	110	14	110	15	110	16	110

Gesamtübersicht aller Zonen

ZONE	1	2	3	4	5	6	7	8
ISTWERT	11	0	0	0	0	0	0	0
ZEIT	0.0	2.0	0	2.0	10	10	10	10
ZONE	9	10	11	12	13	14	15	16
ISTWERT	0	0	0	0	0	0	0	0
ZEIT	10	10	10	10	10	10	10	10

Diagnose Phase2: Zone skip

Beispiel 1 Werkzeug-Diagnose

Diagnose läuft, getestete Zone (hier Zone 1) und verbleibende Testzeit werden angezeigt.

ZONE	1	2	3	4	5	6	7	8
FÜHLER	1	2	3	4	5	6	7	8
HEIZUNG	1	2	-	4	5	6	7	8
ZONE	9	10	11	12	13	14	15	16
FÜHLER	9	10	11	12	13	14	15	16
HEIZUNG	9	10	11	12	13	14	15	16

Diagnose erfolgreich beendet

Beispiel 2 Werkzeug-Diagnose

Diagnose ohne Fehler beendet (Zone 3 war abgeschaltet).

ZONE	1	2	3	4	5	6	7	8
FÜHLER	1	2	3	4	5	6	7	8
HEIZUNG	1	2	-	4	5	6	-	-
ZONE	9	10	11	12	13	14	15	16
FÜHLER	9	10	11	12	13	14	15	16
HEIZUNG	-	-	-	-	-	-	-	-

Fehler: Siehe Anleitung

Beispiel 3 Werkzeug-Diagnose

Diagnose ergab Fehler: Zone 4 Heizung nicht erkannt, Zone 5 und 6 Fühler/Heizung vertauscht. (Zone 7 und 8 Diagnose durch Bediener übersprungen, 9-16 abgeschaltet).

Technische Daten

Betriebsspannung:

230/400 V +/- 10 %, 3~, 48 ... 63 Hz

Nennleistung/Nennstrom:

17,25 kW gesamt / 3 x 25

Heizlast je Zone: 3,6 kW/16 A

Sicherungen:

16 AFF, 6,3 x 32 mm, Heizlasten

Leistungsregelung:

Impulsgruppensteuerung, nullspannungssynchron

Automatische Anfahrsteuerung:

(Werkseinstellungen)

Stellgrad 50 % / Temperatur 80 °C / Zeit 5 min

LCD-Display:

Anzeige von IST-Wert, SOLL-Wert, Alarmmeldungen, Konfigurationsparametern, Alarm-Tendenzen, Istwert-Schreiberfunktion

Sprache wählbar Englisch / Deutsch,

Klartextanzeige für Regel- und Konfigurationsparameter

Sollwert-Umschaltung / Alarmausgänge:

7-polige Buchse:

2 potentialfreie Schließerkontakte für Alarmer, max. 230 V, 3 A, potentialfreier Schalteingang zur Sollwertumschaltung, wirkt auf alle Zonen gemeinsam, intern parallel zu Taster „Standby“

Übertemperatur-Alarm:

0 ... 800 °C wählbar, + 50 °C voreingestellt

Lastbruch-Alarm:

0,0 ... 19,9 A wählbar, 1 A Mindeststrom voreingestellt

Meßfühler-Eingänge:

Fe-CuNi Typ J, 0 ... 800 °C
Andere Typen auf Anfrage

Meßfühler- und Lastanschluß:

16- oder 24-polige Industrie-Standard-Steckverbindung
16 A/400 V, Pinbelegung NR-Norm oder nach Kundenwunsch

Genauigkeit:

0,25 % FS

Isolationsspannung:

2,5 kV, Netz/Elektronik

Abmessungen:

429 x 167 x 380 mm (B x H x T mm)

Farbe Gehäuse:

RAL 3000

Gewicht:

ca. 20 kg (Type 16)

Heißkanal-Programmfunktionen

Über die präzise Temperaturführung jeder Zone hinaus können folgende Programme angewählt werden, je nach Funktion auch für jede Zone einzeln:

Softstart

zum schonenden Anfahren kalter Heizelemente. In dieser Phase sind Stellgrad und Temperatur für eine definierte Zeit begrenzt. Die werksseitig voreingestellten Werte (50 % / 80 °C / 5 min) sind variabel.

Verbundaufheizung

zum Vermeiden von Spannungen im Werkzeug. Alle Zonen werden synchronisiert auf Endtemperatur aufgeheizt, die vorzeitige Überhitzung schneller Einzeldüsen wird so vermieden.

Absenkbetrieb (Stand-By)

Für jede Zone kann ein 2. Sollwert definiert werden, der für alle Zonen zugleich aktiviert werden kann, z.B. zur Temperaturabsenkungen bei Prozeßstörungen, um ein „Auskochen“ der Masse im Werkzeug zu vermeiden.

Soll-/Ist-Vergleich

ZONE	1	2	3	4	5	6	7	8
ISTWERT	125	125	125	125	125	125	125	124
SOLLWERT	125	125	125	125	125	125	125	125
ZONE	9	10	11	12	13	14	15	16
ISTWERT	125	125	125	124	124	125	125	125
SOLLWERT	125	125	125	125	125	125	125	125

Editieren mit Enter starten

Boost

Kurzzeitige Anhebung der Temperatur, z.B. um „eingefrorene“ Düsen freizufahren.

Zone „anhängen“

an eine andere Zone, z.B. bei Fühlerfehler oder unstabiler Regelung als Folge von ungünstiger Fühlerposition.

Sicherheits-Lastabschaltung

Sammelalarm A1, werksseitig als Übertemperaturalarm eingestellt, schaltet zum Schutz vor thermischer Überlastung des Heißkanals die Heizleistung aller Zonen ab. Diese Funktion kann mit einer weiteren Direktwahltaste auf der Gerätefront (rastend mit integrierter Kontrollleuchte) auch deaktiviert werden.

Direktwahltaste

Die am häufigsten benötigte Programme „Stand-by“ und „Boost“ können unabhängig vom Display mit einem Taster an der Gerätefront aktiviert werden. Der „Standby“-Taster ist rastend und mit integrierter Kontrollleuchte ausgeführt.

Überwachungsfunktionen

Laststromanzeige für jede Zone getrennt, 2 frei programmierbare Alarmer pro Zone, z.B. als Temperatur- und Stromalarm. Fühler- und Lastbruch werden automatisch detektiert und als Fehlermeldung auf dem Display angezeigt. Bei Fühlerfehler erfolgt automatisch die Umstellung auf Stellerbetrieb mit dem letzten, aktiven Stellgrad für die jeweilige Zone. „Anhängen“ dieser Zone an eine andere Zone mit intaktem Fühler ist ebenfalls möglich.

Alarmkontakte

Serienmäßig steht ein programmierbarer Alarm als potentialfreier Relaiskontakt zur Verfügung, z.B. Grenzkontakt für Über- oder / und Untertemperatur, Absolutwert etc. Die Alarmkontakte aller Zonen sind auf einen Sammelalarm auf der Geräte rückwand verkabelt, so dass externe Signalisierungen oder Maschineneingänge angeschlossen werden können.

Serie Z 7500 - „Werkzeugdiagnose“

Umfangreiche Werkzeuganalyse gibt Aufschluss über

- **korrekte Zuordnung von Heizung und Fühler**
- **Fühlerverpolung**
- **Fühlerbruch**
- **Lastbruch**

Der Temperaturregler Z 7500 enthält eine Werkzeugdiagnosefunktion mit statischer und dynamischer Analyse.

Im Diagnose-Modus überprüft der Regler das angeschlossene Werkzeug auf ordnungsgemäße Zuordnung der Fühler zur jeweiligen Heizung.

Fühlerfehler wie Fühlerbruch oder Verpolung werden ebenfalls diagnostiziert. Die Diagnosefunktion gibt ebenfalls Aufschluss über ggf. vorliegende Lastbrüche.

Voraussetzung für eine einwandfreie Analyse ist lediglich die ordnungsgemäße Aufteilung der Last- und Fühlerausgänge, d. h. es muss vor Testbeginn sichergestellt sein, dass auf einem Lastausgang kein Fühler angeschlossen ist bzw. umgekehrt.



Während der Diagnosephase werden sämtliche am Test beteiligten Heizzonen nacheinander vorsichtig mit Leistung beaufschlagt, der Regler überprüft dann an Hand des Zeitverhaltens, ob der zur entsprechenden Heizzone gehörende Fühler reagiert oder ob an anderer Stelle ein Temperaturanstieg signalisiert wird

Nach Abschluss aller Tests informiert der Regler, ob das Werkzeug richtig verdrahtet wurde („good“) oder ob Zuordnungsfehler vorliegen („bad“). Die ermittelte Zuordnung von Fühler und Heizung wird für jede Zone angezeigt, entsprechende Korrekturen sind daraufhin leicht gezielt durchzuführen.

Mehrzonentemperaturregler Z 7510



Type 8

Z 7510		Type	Zonen/ max. Last	Leistung gesamt	Netz 3 x 230/400	Abmessungen B x H x T mm
 Z 7510-Type		4	4 x 16 A	17,25 kW	3 x 25 A	324 x 167 x 380
		6	6 x 16 A	17,25 kW	3 x 25 A	324 x 167 x 380
		8	8 x 16 A	17,25 kW	3 x 25 A	324 x 167 x 380

Kompaktregler für alle 230 V Heißkanal-systeme mit 4-8 Heizzonen

Vorteile

- komfortable Bedienung
- übersichtliche Anzeigen
- kompakte Bauform

Das speziell für den Anwendungsbereich Heißkanalregelung optimierte Konzept bietet größtmögliche Regelqualität, einfache Bedienung und umfangreiche Selbstüberwachung. Die Geräte sind unabhängig vom Werkzeughersteller einsetzbar.

Merkmale

- Kompakte Reglereinheit für 10, 12 oder 16 Zonen
- Speziell optimiert für Heißkanal-Anwendungen
- Komfortable, ergonomische Bedienung mit Klartextanzeige

Regelelektronik und Halbleiter-Schalt-elemente vereint in einem kompakten, stabilen Metallgehäuse. Bedientaster und rastende Schalter auf der Gerätefront zur komfortablen Bedienung und Überwachung aller Heizzonen. Seitlich außen angebrachte Lastsicherungen ermöglichen unkomplizierten Sicherungswechsel im Fehlerfall.

- Automatische Regelstrecken-anpassung jeder Zone
- Integrierte Laststromkontrolle
- Intelligente, frei programmierbare Softstartroutine

Mikroprozessorregler mit automatischer Regelstrecken-anpassung für optimale Regelqualität an flinken Düsenheizungen wie an trägen Verteilerstrecken. Zahlreiche Regelparameter sind anwendungsspezifisch einstellbar, daher kann der Regler auch an komplexen und schwierigen Werkzeugen präzise betrieben werden. Die Optimierung kann auch nachträglich im Heißbetrieb gestartet werden.

LCD-Bildschirm mit Schreiberfunktion

Der helle LCD-Bedienbildschirm erlaubt eine einfache, klar gegliederte Übersicht über alle wichtigen Funktionen und Betriebszustände.

Alternativ können alle Zonen mit IST-Temperaturen, Soll/Ist-Vergleich oder alle Detailangaben jeder einzelnen Zone dargestellt werden. Zusätzlich sind eine Trendanzeige sowie eine grafische Schreiberfunktion für den zeitlichen Verlauf der IST-Temperatur möglich.



Heißkanal-Programmfunktionen

Über die präzise Temperaturführung jeder Zone hinaus können folgende Programme angewählt werden, je nach Funktion auch für jede Zone einzeln:

Sofstart

zum schonenden Anfahren kalter Heizelemente. In dieser Phase sind Stellgrad und Temperatur für eine definierte Zeit begrenzt. Die werksseitig voreingestellten Werte (50 % / 80 °C / 5 min) sind variabel.

Absenkbetrieb (Stand-By)

Für jede Zone kann ein 2. Sollwert definiert werden, der für alle Zonen zugleich aktiviert werden kann, z.B. zur Temperaturabsenkungen bei Prozeßstörungen, um ein „Auskochen“ der Masse im Werkzeug zu vermeiden.

Verbundaufheizung

zum Vermeiden von Spannungen im Werkzeug. Alle Zonen werden synchronisiert auf Endtemperatur aufgeheizt, die vorzeitige Überhitzung schneller Einzeldüsen wird so vermieden.

Boost

Kurzzeitige Anhebung der Temperatur, z.B. um „eingefrorene“ Düsen freizufahren.

Zone „anhängen“

an eine andere Zone, z.B. bei Fehlerfehler oder unstabiler Regelung als Folge von ungünstiger Fühlerposition.

Direktwahltaste

Die am häufigsten benötigte Programme „Stand-by“ und „Boost“ können unabhängig vom Display mit einem Taster an der Gerätefront aktiviert werden. Der „Standby“-Taster ist rastend und mit integrierter Kontrollleuchte ausgeführt.

Überwachungsfunktionen / Alarmkontakt

Laststromanzeige für jede Zone getrennt, 2 frei programmierbare Alarme pro Zone, z.B. als Temperatur- und Stromalarm. Fühlerbruch wird automatisch detektiert und als Fehlermeldung auf dem Display angezeigt. Bei Fühlerfehler erfolgt automatisch die Umstellung auf Stellerbetrieb mit dem letzten, aktiven Stellgrad für die jeweilige Zone. Die beiden Alarme sind zusätzlich für alle Zonen jeweils als Sammelalarm auf eine externe Geräte-Kontaktbuchse verkabelt, z.B. zum Anschluß an die Spritzgußmaschine.

Technische Daten

Betriebsspannung:

230/400 V +/- 10 %, 3~, 48 ... 63 Hz

Nennleistung/Nennstrom:

17,25 kW gesamt / 3 x 25 A

Heizlast je Zone: 3,6 kW/16 A

Sicherungen:

16 AFF, 6,3 x 32 mm, Heizlasten

Leistungsregelung:

Impulsgruppensteuerung, nullspannungssynchron

Automatische Anfahrsteuerung:

(Werkseinstellungen)

Stellgrad 50 % / Temperatur 80 °C / Zeit 5 min

LCD-Display:

Anzeige von IST-Wert, SOLL-Wert, Alarmmeldungen, Konfigurationsparametern, Alarm-Tendenzen, Istwert-Schreiberfunktion

Sprache wählbar Englisch / Deutsch,

Klartextanzeige für Regel- und Konfigurationsparameter

Sollwert-Umschaltung / Alarmausgänge:

7-polige Buchse:

2 potentialfreie Schließerkontakte für Alarme, max. 230 V, 3 A, potentialfreier Schalteingang zur Sollwertumschaltung, wirkt auf alle Zonen gemeinsam, intern parallel zu Taster „Standby“

Übertemperatur-Alarm:

0 ... 800 °C wählbar, + 50 °C voreingestellt

Lastbruch-Alarm:

0,0 ... 19,9 A wählbar, 1 A Mindeststrom voreingestellt

Meßfühler-Eingänge:

Fe-CuNi Typ J, 0 ... 600 °C

Andere Typen auf Anfrage

Meßfühler- und Lastanschluß:

16- oder 24-polige Industrie-Standard-Steckverbindung 16 A/400 V, Pinbelegung NR-Norm oder nach Kundenwunsch

Genauigkeit:

0,25 % FS

Isolationsspannung:

2,5 kV, Netz/Elektronik

Abmessungen:

324 x 167 x 380 mm (B x H x T mm)

Farbe Gehäuse:

RAL 3000

Gewicht:

ca. 11,4 kg (Type 8)

Temperaturregler Z 7520



Type 1

Type 2

Z 7520	Type	Heizzonen
 Z 7520-Type	1	1
	2	2

Kompaktregler für alle 230 V Heißkanaldüsen mit 1 oder 2 Heizzonen

Vorteile

- Integriertes Lastschaltteil 230 V/10 A pro Zone
- Digitale Soll- und Istwertanzeige
- Mikroprozessorbasierter PID-Regler mit Autotuning
- 2 Alarme programmierbar, externer Sammelalarm

Anwendung

Das handliche Gerät wurde speziell für die Belange der kunststoffverarbeitenden Industrie entwickelt und eignet sich besonders für Einzeldüsen – auch mit sehr flinker Charakteristik –, Zusatzheizungen sowie für Versuchsaufbauten und Kleinanlagen.

Der Temperaturregler bietet eine preisgünstige Möglichkeit, einzelne Heizkreise mit Heizleistungen bis 2,3 kW mit hoher Genauigkeit und Stabilität zu regeln.

Aufbau

Anschlußfertiger Kompaktregler zur Einzelaufstellung. Netzanschlußkabel mit Schukostecker.

Funktion / Regelung

Mikroprozessorregler mit automatischer Regelstrecken Anpassung für optimale Regelqualität an flinken Düsenheizungen wie an trägen Verteilerstrecken und Extruderzonen. Es stehen zwei wählbare PID-Regelcharakteristiken zur Verfügung: „Autotuning“ (Überschwingen wird zugelassen, schneller und genauer) sowie „Selftuning“ (kein Überschwingen, langsamer). Weiterhin kann der Regler als reiner 2-Punktregler oder auch als manueller Steller eingestellt werden.

Temperaturanzeige

Das helle, übersichtliche LED-Display zeigt im Normalbetrieb im oberen Teil die IST-Temperatur, im unteren Teil den Temperatur-Sollwert des Regelkreises an.

Auf Tastendruck wechselt die Anzeige zu weiteren Betriebsparametern, z.B. Stellgrad, Alarmgrenzwerte, Konfigurationsparameter etc.

SOLL-Temperatureingabe

Mit der Eingabetaste zunächst die gewünschte Dezimalstelle anwählen (große Sollwertänderungen sind so schnell möglich). Mit den UP/DOWN-Tasten erfolgt dann die Einstellung des Temperatur-Sollwertes. Übernahme des neuen Wertes kann manuell oder automatisch erfolgen.

Softstart

Zum Begrenzen der Leistung beim Anfahren empfindlicher Heizelemente kann ein Softstart gewählt werden, Softstartdauer und -stellgrad sind dabei frei einstellbar.

Fühlerüberwachung

Fühlerbruch wird automatisch detektiert und als Fehlermeldung im Display angezeigt.

Alarmkontakte

Serienmäßig steht ein programmierbarer Alarm als potentialfreier Relaiskontakt zur Verfügung, z.B. Grenzkontakt für Über- oder / und Untertemperatur, Absolutwert etc. Der Alarmkontakt (bzw. beide bei 2 Zonen) sind auf einen Sammelalarm auf der Geräterückwand verkabelt, so dass externe Signalisierungen oder Maschineneingängegeschlossen werden können.



Soll- und Istwertanzeige

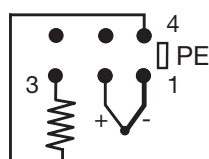

Steckerbelegung 1-Zone

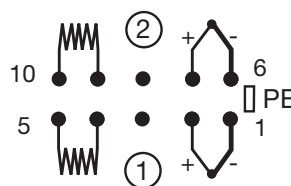

Steckerbelegung 2-Zonen

Technische Daten

Betriebsspannung	230 V~ +/-10 %, 50/60 Hz
Nennleistung/Nennstrom	Regler 2,3 kW/10 A pro Zone
Heizlasten	16 A bei 2 Zonen
Sicherungen	Heizung: 10 A, 6,3 x 32 mm Regler: 500 mA 5 x20 mm
Leistungsregelung	Impulsgruppensteuerung, nullspannungssynchron
Softstart	Softstartdauer (min) und -stellgrad (0...100 %) frei wählbar
LED-Display	7-Segment LED-Anzeigen 8 mm grün (Istwert) und rot (Sollwert) Signal-LED rot für Stellausgang und Alarm
Regelgenauigkeit	0,5 % FS
Temperaturbereich	Fe-CuNi Typ J 0...900 °C (mit oder ohne Nachkommastelle) NiCr/Ni oder Pt 100 auf Anfrage erhältlich
Alarmausgang	Relais, potentialfrei, max 250 V~, 5 A. Als Sammelalarm verkabelt auf 7-pol. Alarmbuchse auf der Geräterückwand
Umgebungstemperaturbereich	0...55 °C
Isolationsspannung	2,5 kV Netz/Elektronik
Last- und Fühleranschluss	6-pol. + PE (1 Zone) bzw. 10-pol. + PE (2 Zonen) Industrie-Normsteckdose 7-pol. + PE für Alarmkontakt
Ausführung	Gerät für Einzelaufstellung, Schutzart IP 51
Abmessungen	217 x 110 x 250 mm (B x H x T)
Gewicht	4,2 kg

Grundeinheit Z 7530 GC für Regeleinschübe Z 7538-RE-14



Type 2



Type 30

Z 7530 GC-



Z 7530 GC-
Type-Kontakt



230 V/400 V/48-63 Hz

Type	Kontakt	P	K	A x B x H	kg
2	16	1 x 16	1 x 25 A	200 x 250 x 160	3,5
4	16	1 x 16	2 x 20 A	325 x 250 x 160	4,5
6	16	2 x 16	3 x 25 A	490 x 300 x 160	9,4
6	24	1 x 24	3 x 25 A	490 x 300 x 160	9,4
12	16	3 x 16	3 x 45 A	510 x 320 x 300	15,5
12	24	2 x 24	3 x 45 A	510 x 320 x 300	15,5
18	24	3 x 24	3 x 45 A	510 x 420 x 475	24,8
24	24	4 x 24	3 x 60 A	510 x 420 x 655	27,2
30	24	5 x 24	3 x 60 A	510 x 420 x 840	33,5

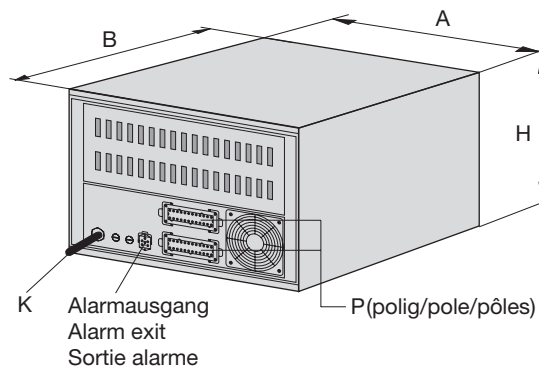
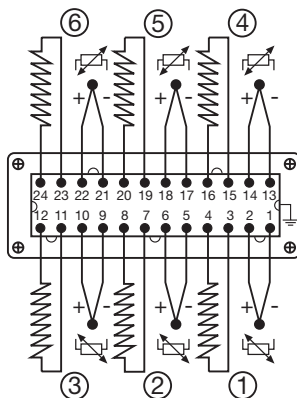
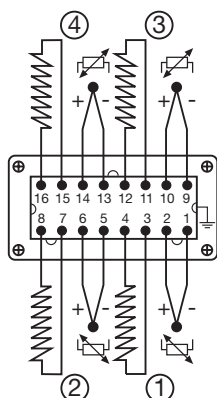

Grundeinheit Z 7530 GC für Regeleinschübe Z 7538-RE-14

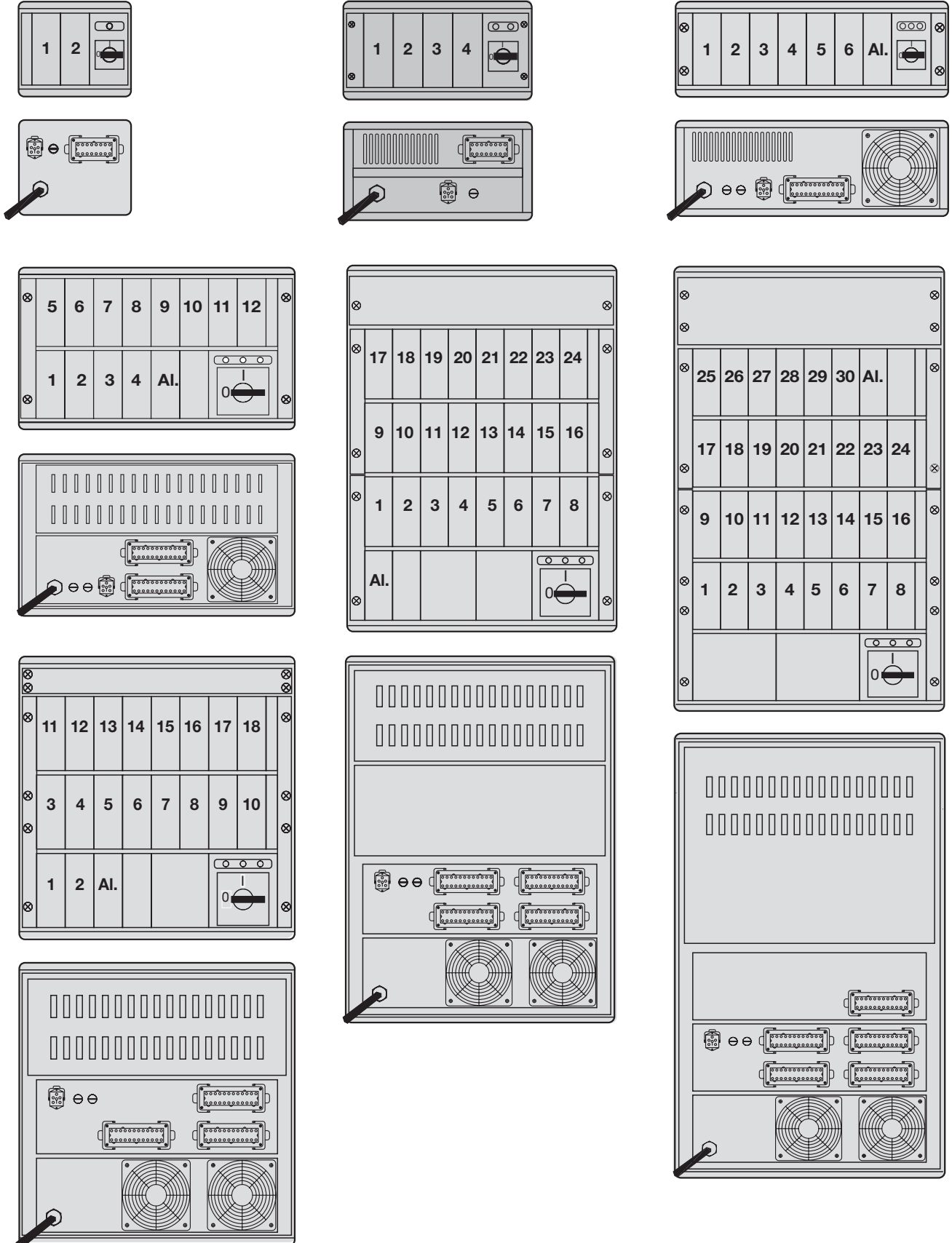

Regler Einschübe Z 7538 RE-14



Z 7538 RE-14



Z 7538 RE-14



Merkmale

19"- Microprozessor-Temperaturregler-Einschub steckkompatibel mit Type Z 7530 GC

- mit integriertem Lastschaltanteil 230 V~/12,5 A
- mit integriertem Stromwandler
- Bargraphen für zusätzliche Regelabweichungsanzeige sowie analoge Stromkontrolle
- Microprozessor-Regler mit umfangreichen automatischen Überwachungsfunktionen
- „Boost“-Funktion zum kontrollierten „Freifahren“ des Werkzeuges
- Automatische Regelstrecken Anpassung
- Besonders einfache 3-Tasten-Bedienung

Technische Daten

Betriebsspannung: 230 V ± 10 %, 48 ... 63 Hz

Nennleistung/Nennstrom Heizlast: 2,85 kW/12,5 A

Sicherungen:

1,6A FF, 6,3 x 32 mm (Heizlast)

1,6A MT, 5 x 20 mm (Kühlaustrag)

0,1A MT, 5 x 20 mm (Steuerung)

Leistungsregelung:

Impulsgruppensteuerung, nullspannungssynchronisiert

Leistungsbegrenzung: 60 %

Automatische Anfahrsteuerung:

temperaturabhängig, 20 s - 9 min, leistungs- und

temperaturbegrenzt ($\vartheta_{max} = 80\text{ °C}$)

Boost-Funktion:

einmaliges, kontrolliertes Überheizen nach Anfahren, frei wählbar 0...9 K

LED-Display:

Anzeige von Ist-Wert, Soll-Wert, Laststrom, Alarmmeldungen, Fühlerverpolung, Triacfehler

LED-Bargraphen:

10-Element Stromanzeige

10-Element Regelabweichung

Modus-LEDs: Normalbetrieb, manueller Stellerbetrieb, Stromanzeige, 60 % Begrenzung

Alarm-/Info-LEDs: Lastbruch, Fühlerbruch, Übertemperatur, Untertemperatur, Kühlung (optional)

Sicherheits-Lastabschaltung:

Mechanisches Relais öffnet übertemperaturabhängig

Limit-Komparatoren: +3...99 K, -3...99 K

je 1 Relaiskontakt gegen N schaltend

Messfühler-Eingang:

Thermoelement gem. DIN IEC 584

FE-CuNi Typ J: 0...450 °C

NiCr-Ni Typ K: 0...999 °C

Pt100: 0...450 °C

automatische Nullpunkt Korrektur und Verpolungsschutz bei Thermoelement, Fühlerbruch-Sicherheitsfunktion

Kühlaustrag: (optional)

230 V~/120 VA

Regelverhalten: adaptiv, DPID-Charakteristik

Genauigkeit: 0,5 % f.s.

Isolationsspannung: 2,5 kV Netz/Elektronik

Abmessungen: 50,5 x 128,5 x 195 mm (B x H x T)

Format: 19"/3HE / 10TE

Stecker: H11 DIN 41612

Gewicht: 0,8 kg

Blindplatten für Grundeinheit Z 7530 GC

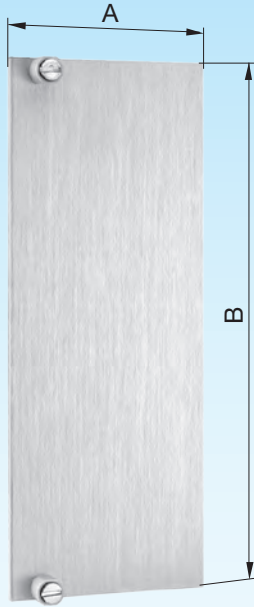

Einschubplätze, die nicht durch Regler oder Steller belegt sind, müssen durch Blindplatten abgedeckt werden.

Z 7556 B-

 Z 7556 B-Type



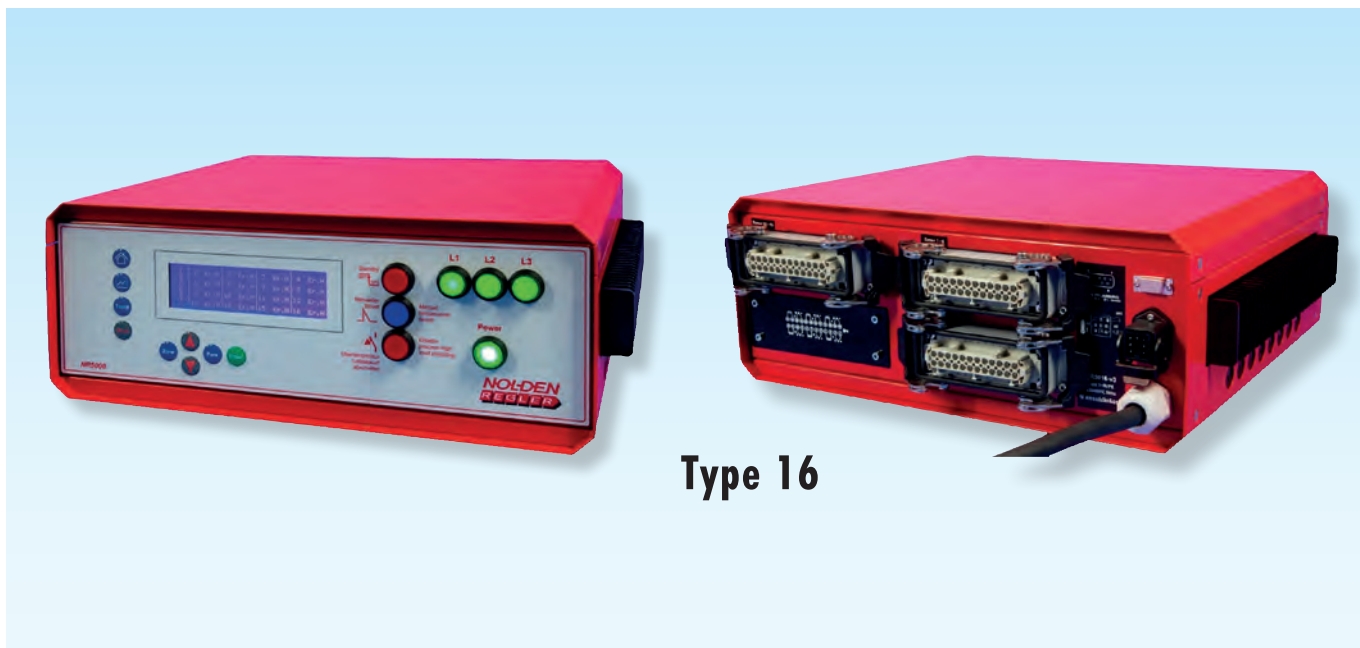

Type	A	B
1	50	128
2	100	128

Multizones temperature controllers Z 7500



Type 16

Z 7500		Type	Zones, maximum load	Total power	Net 3 x 230/400	Dimensions W x H x D mm
 Z 7500-Type		10	10 x 16 A	17.25 kW	3 x 25 A	429 x 167 x 380
		12	12 x 16 A	17.25 kW	3 x 25 A	429 x 167 x 380
		16	16 x 16 A	17.25 kW	3 x 25 A	429 x 167 x 380

Compact controller for all 230 V hot runner systems with 10-16 heating zones

Advantages

- Comfortable operation
- Clear displays
- Compact construction

The concept was specially designed for hot-runner applications and therefore comes up with high temperature-stability, easy operation and numerous self-monitoring-features. All units are usable regardless of the mould manufacturer.

Characteristics

- Compact controller for 10, 12 or 16 zones
- Specially designed for hotrunner applications
- Easy to understand, user friendly operation
- Automatic adaptation to the controlled system
- Integrated load-current monitor
- Many programmable specific hotrunner functions
- Comes standard with mould diagnosis function

Control-electronics and solid-state relays are combined in one compact, rugged metal casing. Load-fuses are mounted on the side and thus provide an easy access in case of failure. Bright LCD-display for comfortable and simple control and operation of all zones plus dedicated keys for the most common functions.

Microprocessor controller with self-tuning function: automatically determines the control-characteristics of each heating zone and adapts the control parameters accordingly. This assures optimal temperature control for quick hot-tips as well as for slow manifold heaters. Many control parameters can be set-up specific, this makes the controller an ideal unit for complex and difficult moulds. Unique feature: Auto-tuning can be started in hot operation as well.

LCD-display with tracing function

The bright LCD-display permits an easy, quick overview on all important functions and control parameters. On request, it shows all zones together (actual temperature) or every zone in detail. Furthermore, a trend display and a tracing function are available, which shows the variation in actual temperature for a given zone.



Detail view single zone



Tracing function single zone

100- Zonen- T	1	110	2	110	3	110	4	110
	5	110	6	110	7	110	8	110
	9	110	10	110	11	110	12	110
	13	110	14	110	15	110	16	110

Overview all zones

ZONE	1	2	3	4	5	6	7	8
ISTWERT	11	0	0	0	0	0	0	0
ZEIT	0.0	2.0	0	2.0	10	10	10	10
ZONE	9	10	11	12	13	14	15	16
ISTWERT	0	0	0	0	0	0	0	0
ZEIT	10	10	10	10	10	10	10	10

Diagnose Phase2: ← Zone skip

Example 1 mould-diagnosis

Diagnosis running, actually tested zone (here zone 1) and remaining testing time are shown.

ZONE	1	2	3	4	5	6	7	8
FÜHLER	1	2	3	4	5	6	7	8
HEIZUNG	1	2	-	4	5	6	7	8
ZONE	9	10	11	12	13	14	15	16
FÜHLER	9	10	11	12	13	14	15	16
HEIZUNG	9	10	11	12	13	14	15	16

Diagnose erfolgreich beendet

Example 2 mould-diagnosis

Diagnosis terminated without failure (zone 3 was switched off).

ZONE	1	2	3	4	5	6	7	8
FÜHLER	1	2	3	4	5	6	7	8
HEIZUNG	1	2	-	4	6	5	-	-
ZONE	9	10	11	12	13	14	15	16
FÜHLER	9	10	11	12	13	14	15	16
HEIZUNG	-	-	-	-	-	-	-	-

Fehler: Siehe Anleitung

Example 3 mould-diagnosis

Heater zone 4 not found, sensor / heater zones 5 and 6 interchanged. (Diagnosis zones 7 and 8 manually skipped by the operator, 9-16 switched off).

Technical data

Mains voltage:
230/400 V +/-10 %, 3~, 48 ... 63 Hz

Nominal rating / nominal current:
17.25 kW/3 x 25 A total

Heating load per zone: 3.6 kW/16 A

Fuses:
16 AFF, 6.3 x 32 mm, heating

Power control:
0 - 100 % proportional, zero-voltage switching

Automatic soft-start:
(factory default settings)
Power-setting 50 % / temp. 80 °C / time 5 min

LCD-Display:
Shows actual temperature, setpoint, alarms, configuration parameter, tracing function
Language choice English / German, plain language information for control- and configuration-parameters.

External stand-by / alarm exit:
7 pin connector:
2 floating relay contacts for alarms, max. 230 V, 3 A, floating input for external stand-by, works on all zones together, wired in parallel with internal "Stand-by"-key on the front panel.

Process-high-alarm:
0 ... 800 °C programmable, default value +50 °C

Low current-alarm:
0,0 ... 19.9 A programmable, default value 1 A minimum current

Sensor input:
Fe-CuNi Typ J, 0 ... 600 °C
Other types on request

Sensor and heater connection:
16- or 24-pin industrial heavy duty standard-connector
16 A/400 V, pin assignment following NR-norm, other pin assignments available.

Precision:
0.25 % FS

Isolation voltage:
2.5 kV, mains / controller

Dimensions:
429 x 167 x 380 mm (W x H x D mm)

Colour:
RAL 3000

Weight:
about 20 kg (type 16)

Specific hotrunner functions

Beside the very precise temperature control of every zone, numerous hotrunner program functions can be chosen, for all zones together or for every single zone as appropriate. The most important ones are:

Soft-start

During soft-start, the controller unit works with reduced temperature and power setting (factory-defaults: 50 % / 80 °C / 5 min). Cold heaters are gently pre-heated, moisture is expelled.

Guided heat-up

All zones can be heated-up together - avoids hot-tips being at set-point temperature before the slower manifold zones and prevents stress inside the mould during start-up.

Stand-by operation

Each heating-zone is equipped with a second temperature set-point. By pressing the "stand-by"-button or closing an external contact, all zones simultaneously are switched over to the second set-point, which may be used for stand-by operation.

Actual value / setpoint comparison

ZONE	1	2	3	4	5	6	7	8
ISTWERT	125	125	125	125	125	125	125	124
SOLLWERT	125	125	125	125	125	125	125	125
ZONE	9	10	11	12	13	14	15	16
ISTWERT	125	125	125	124	124	125	125	125
SOLLWERT	125	125	125	125	125	125	125	125

Edytieren mit Enter starten

Boost

Single-time override of the desired temperature-value melts "frozen" nozzles.

"Zone coupling"

Coupling of a zone to any other zone with working thermocouple is also possible, e.g in case of a broken thermocouple or instable control due to a bad position of the sensor.

"Safety-shutdown heating"

The 1st alarm, typically program-med as high-temperature alarm, is wired to the central safety masterswitch of the unit. This prevents damage of the mould with too high actual temperature and avoids costly repair. If desired, this safety function can be temporarily switched off in the set-up phase of a new mould.

Direct access keys

The most common hotrunner functions "Boost" and "Stand-by" can be started independantly from the display with a dedicated key on the front panel. The stand-by key is lighted to remember the activation of this function.

Process survey functions

Load current monitoring for every zone independently, 2 programmable alarms per zone, sensor and heater breakage are detected automatically and will be displayed on the screen. If sensor breakage happens, the controller automatically switches over to constant power-setting with the last assigned value for this zone. Manual overriding of this value is possible at any time. Beside those alarms, many other process parameters can be set-up and surveyed as well.

External alarm output

The 2 alarms on every zone are combined by a floating contact as common alarm output for the whole unit and wired to an external alarm connector on the back side. This permits a connection with external units such as an injection moulding machine or central production alarm system. The external stand-by input is wired on this connector as well.

Series Z 7500 - "tool diagnosis"

Extensive tool analyses provides information on

- **Correct assignment of heating and thermo couple**
- **Thermo couple incorrect polarity**
- **Thermo couple break**
- **Load break**

In addition to the described control functions of the temperature controller Z 7500 contains a tool diagnosis function with a static and dynamic analysis.

In the diagnostic mode the controller checks the connected tool concerning the correct assignment of the thermo couple to the respective heating.

Thermo couple errors like thermo couple break or incorrect polarity are also diagnosed. The diagnosis function also provides information about existing load breaks as the case may be.

The condition for a correct diagnosis is only the proper distribution of the load- and thermo couple outputs, that means that before starting the test it must be secured, that on a load output no thermo couple is connected and vice versa.



During the diagnosis, all heating zones involved in the test, are cautiously charged successively, and then the controller checks with the help of the time behaviour if the thermo couple which belongs to the respective heating zones reacts or if a temperature increase at another place is signalized.

After completion of all tests the controller informs if the tool has been wired correctly ("good") or if there are assignment errors ("bad"). The identified assignment of heating and thermo couple is indicated for each zone, thereupon corresponding corrections can be made easily.

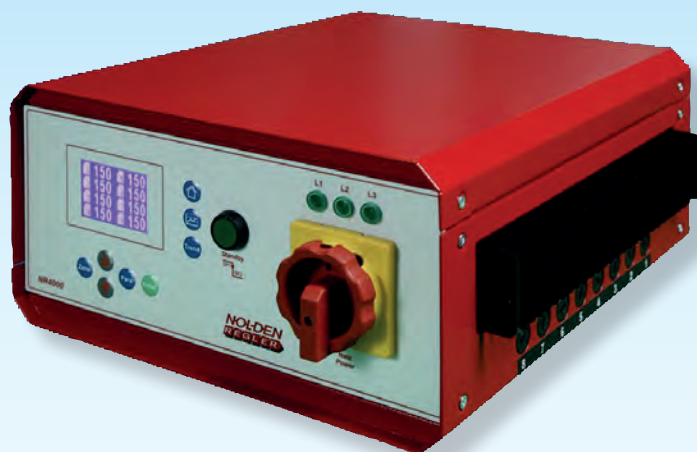
Multizones temperature controller Z 7510



Type 8

Z 7510		Type	Zones, maximum load	Total power	Net 3 x 230/400	Dimensions W x H x D mm
 Z 7510-Type		4	4 x 16 A	17.25 kW	3 x 25 A	324 x 167 x 380
		6	6 x 16 A	17.25 kW	3 x 25 A	324 x 167 x 380
		8	8 x 16 A	17.25 kW	3 x 25 A	324 x 167 x 380

Compact controller for all 230 V hot runner systems with 4-8 heating zones

Advantages

- Comfortable operation
- Clear displays
- Compact construction

The concept was specially designed for hot-runner applications and therefore comes up with high temperature-stability, easy operation and numerous self-monitoring-features. All units are usable regardless of the mould manufacturer.

Characteristics

- Compact controller for 4, 6 or 8 zones
- Specially designed for hotrunner applications
- Easy to understand, user friendly operation
- Automatic adaptation to the controlled system
- Integrated load-current monitor
- Intelligent, programmable soft-start routine

Control-electronics and solid-state relays are combined in one compact, rugged metal casing. Load-fuses are mounted on the side and thus provide an easy access in case of failure. Bright LCD-display for comfortable and simple control and operation of all zones plus dedicated keys for the most common functions.

Microprocessor controller with self-tuning function: automatically determines the control-characteristics of each heating zone and adapts the control parameters accordingly. This assures optimal temperature control for quick hot-tips as well as for slow manifold heaters. Many control parameters can be set-up specific, this makes the controller an ideal unit for complex and difficult moulds. Unique feature: Auto-tuning can be started in hot operation as well.

LCD-display with tracing function

The bright LCD-display permits an easy, quick overview on all important functions and control parameters. On request, it shows all zones together (actual temperature) or every zone in detail. Furthermore, a trend display and a tracing function are available, which shows the variation in actual temperature for a given zone.



Specific hotrunner functions

Beside the very precise temperature control of every zone, numerous hotrunner program functions can be chosen, for all zones together or for every single zone as appropriate. The most important ones are:

Soft-start

During soft-start, the controller unit works with reduced temperature and power setting (factory-defaults: 50 % / 80 °C / 5 min). Cold heaters are gently pre-heated, moisture is expelled.

Guided heat-up

All zones can be heated-up together - avoids hot-tips being at set-point temperature before the slower manifold zones and prevents stress inside the mould during start-up.

Stand-by operation

Each heating-zone is equipped with a second temperature set-point. By pressing the "stand-by"-button or closing an external contact, all zones simultaneously are switched over to the second set-point, which may be used for stand-by operation.

Boost

Single-time override of the desired temperature-value melts "frozen" nozzles.

"Zone coupling"

Coupling of a zone to any other zone with working thermocouple is also possible, e.g in case of a broken thermocouple or instable control due to a bad position of the sensor.

Direct access key

The most common hotrunner functions "Boost" and "Stand-by" can be started independantly from the display with a dedicated key on the front panel. The stand-by key is lighted to remember the activation of this function.

Process survey functions

Load current monitoring for every zone independently, 2 programmable alarms per zone, sensor and heater breakage are detected automatically and will be displayed on the screen. If sensor breakage happens, the controller automatically switches over to constant power-setting with the last assigned value for this zone. Manual overriding of this value is possible at any time. Beside those alarms, many other process parameters can be set-up and surveyed as well.

Technical data

Mains voltage:

230/400 V +/- 10 %, 3~, 48 ... 63 Hz

Nominal rating / nominal current:

17.25 kW gesamt / 3 x 25 A

Heating load per zone: 3.6 kW/16 A.

Fuses:

16 AFF, 6.3 x 32 mm, heating

Power control:

0 - 100 % proportional, zero-voltage switching

Automatic soft-start:

(factory default settings)

Power-setting 50 % / temp. 80°C / time 5 min

LCD-Display:

Shows actual temperature, setpoint, alarms, configuration parameter, tracing function
Language choice English / German, plain language
information for control- and configuration-parameters.

External stand-by / alarm exit:

7 pin connector:

2 floating relay contacts for alarms, max. 230 V, 3 A, floating input for external stand-by, works on all zones together, wired in parallel with internal „Stand-by“-key on the front panel.

Process-high-alarm:

0 ... 800 °C programmable, default value +50 °C

Low current-alarm:

0.0 ... 19.9 A programmable, default value 1 A minimum current

Sensor input:

Fe-CuNi Typ J, 0 ... 600 °C

Other types on request

Sensor and heater connection:

16- or 24-pin industrial heavy duty standard-connector
16 A/400 V, pin assignment following NR-norm,
other pin assignments available

Precision:

0.25 % FS

Insulation voltage:

2.5 kV, mains / controller

Dimensions:

324 x 167 x 380 mm (W x H x D mm)

Colour:

RAL 3000

Weight:

ca. 11.4 kg

Temperature controller Z 7520



Type 1

Type 2

Z 7520	Type	Heating zones
 Z 7520-Type	1	1
	2	2

Compact controller for all 230 V hot runner nozzles with 1 or 2 heating zones

Advantages

- Integrated load switching part 230 V/10 A per zone
- Digital setpoint- and actual value display
- Microprocessor-based PID controller with autotuning
- 2 alarms can be programmed, external collective alarm

Application

The handy device was especially developed for the requirements of the plastic processing industry and is particularly suited for single nozzles – also with quick characteristic –, supplementary heating systems as well as for experimental setups and small plants.

The temperature controller offers an inexpensive possibility to control single heating circuits with heating performances till 2,3 kW with high accuracy and stability.

Assembly

Ready-to-connect compact controller for separate mounting. Power cord with shock-proof plug.

Function / control

Microprocessor controller with automatic control path adaptation for optimal control quality at speedy nozzle heatings as well as at slow distribution routes and extruder zones. Two selectable PID-control characteristics are available: "Autotuning" (overshoot is allowed, quicker and more precise) as well as "Selftuning" (no overshoot, slower). Furthermore the controller can be adjusted as a pure two-point controller or as manual actuator.

Temperature display

The light and clear LED-display shows during normal operation in the upper part the actual temperature, in the lower part the temperature setpoint of the control circuit.

At the push of a button the display changes to other operating parameters, for example regulation ratio, alarm limit values, configuration parameters and so on.

Temperature setpoint input

First of all select the desired decimal point by using the input key (thus great setpoint changes are quickly possible). Then the adjustment of the temperature setpoint is effected with the UP/DOWN keys. The acceptance of the new value can take place manually or automatically.

Softstart

For limiting the power when starting sensitive heating systems a softstart can be selected, the duration of the soft start and the regulation ratio can be freely adjusted.

Thermo couple control

Thermo couple break is automatically detected and indicated as error message on the display.

Alarm contacts

As standard a programmable alarm as potential-free relay contact is available, for example limit contact for over- or/and undertemperatur, absolute value and so on ...

The alarm contact (respectively both at 2 zones) are wired on a collective alarm on the backside of the device, so that external signaling or machine entries can be connected.



setpoint- and actual value display

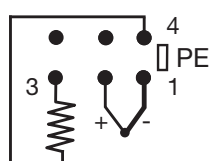

Connector assignment 1-zone

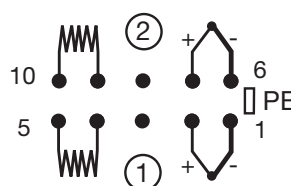

Connector assignment 2-zones

Technical Data	
Operating voltage	230 V~ +/-10 %, 50/60 Hz
Nominal output/nominal current:	Controller 2.3 kW/10 A per zone
Heating load	16 A at 2 zones
Fuses	Heating: 10 A, 6.3 x 32 mm Controller: 500 mA 5 x 20 mm
Power control	Impulse group control, zero voltage synchronous
Softstart	Duration of soft start (min) and proportional ratio (0...100 %) free selectable
LED-display	7-segment LED-displays 8 mm green (actual value) and red (setpoint) Signal LED red for control output
Control precision	0.5 % FS
Temperature range	Fe-CuNi Typ J 0...900 °C (with or without position after decimal point) NiCr/Ni or Pt 100 available on request
Alarm outputs	Relays, potential-free, max 250 V~, 5 A. as collective alarm wired on 7-poles alarm bush on the backside of the device.
Environment temperature range	0...55 °C
Isolation voltage	2,5 kV net/electronics
Load- and sensor connection	6-poles + PE (1 zone) respectively 10-poles (2 zones), 7-poles industrial standard socket +PE for alarm contact
Model	Device for separate mounting, protection type IP 51
Dimensions	217 x 110 x 250 mm (W x H x D)
Weight	4.2 kg

Basic unit Z 7530 GC for controller modules Z 7538-RE-14



Type 2



Type 30

Z 7530 GC-



Z 7530 GC-
Type-Kontakt



230 V/400 V/48-63 Hz

Type	Kontakt	P	K	A x B x H	kg
2	16	1 x 16	1 x 25 A	200 x 250 x 160	3.5
4	16	1 x 16	2 x 20 A	325 x 250 x 160	4.5
6	16	2 x 16	3 x 25 A	490 x 300 x 160	9.4
6	24	1 x 24	3 x 25 A	490 x 300 x 160	9.4
12	16	3 x 16	3 x 45 A	510 x 320 x 300	15.5
12	24	2 x 24	3 x 45 A	510 x 320 x 300	15.5
18	24	3 x 24	3 x 45 A	510 x 420 x 475	24.8
24	24	4 x 24	3 x 60 A	510 x 420 x 655	27.2
30	24	5 x 24	3 x 60 A	510 x 420 x 840	33.5

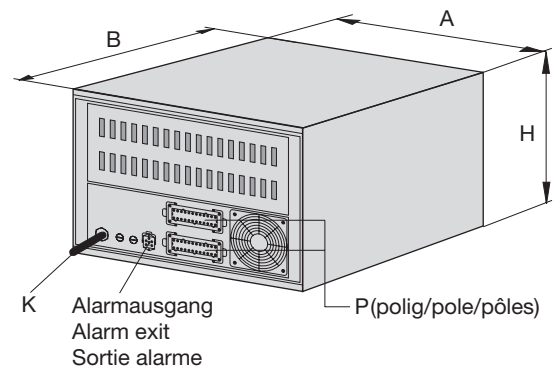
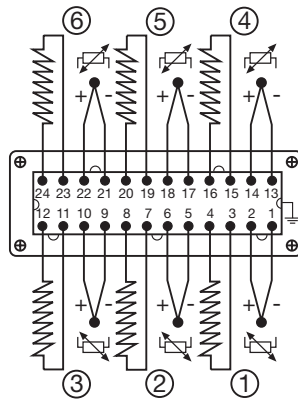
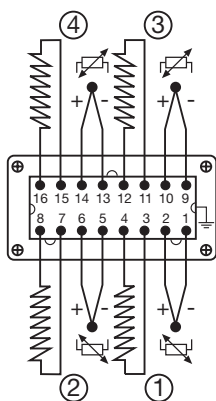

Basic unit Z 7530 GC for controller modules Z 7538-RE-14

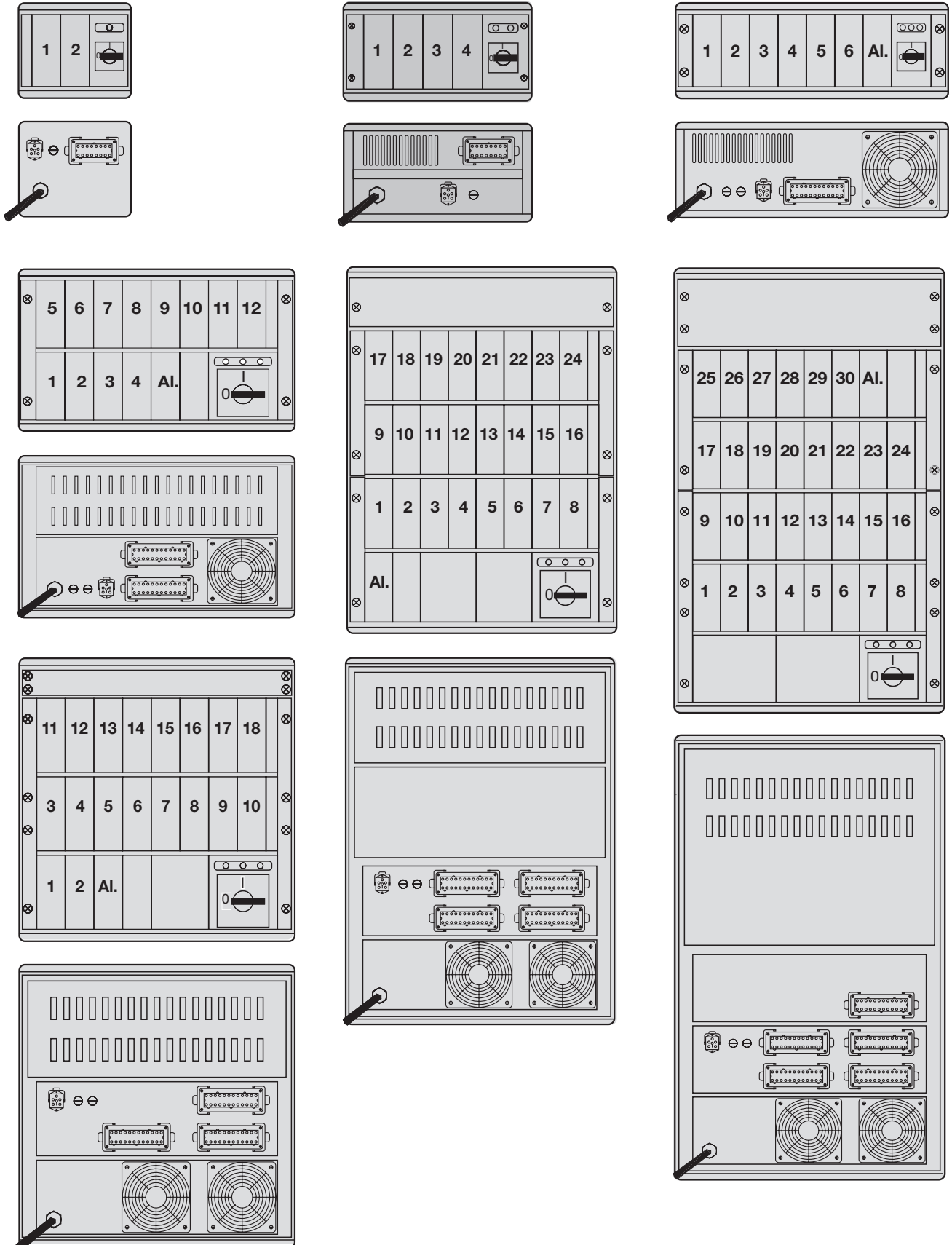

Controller modules Z 7538 RE-14



Z 7538 RE-14



Z 7538 RE-14



Characteristics

19"-microprocessor-temperature controller-module plug compatible with the type Z 7530 GC

- With integrated load switching portion 230 V~/12.5 A
- With integrated current transformer
- Bargraphs for additional indication of control deviation as well as analog current control
- Microprocessor-controller with comprehensive automatic control functions
- "Boost"-function controlled "short overheating" of the tool
- Automatic adaptation to control path
- Particularly simple 3-button-operation

Technical Data

Operating voltage: 230 V ± 10 %, 48 ... 63 Hz

Nominal output/nominal current: 2.85 kW/12.5 A

Fuses:

16A FF, 6.3 x 32 mm (heating load)

1.6A MT, 5 x 20 mm (cooling output)

0.1A MT, 5 x 20 mm (control)

Power control:

Impulse group control, zero voltage synchronous

Power limitation: 60 %

Automated drive control:

Depending on temperature, 20 s - 9 min, power- and temperature limited ($\Theta_{max} = 80 \text{ °C}$)

Boost-Function: one-time, controlled overheating after starting, freely selectable 0...9 K

LED-display:

Display of actual value, setpoint, load current, alarm signals, thermo couple incorrect polarity, triac error

LED-bargraphs: 10-element power current indicator, 10-element control deviation

Modus-LEDs: Normal operation, manual control, current indicator, 60 % limitation.

Alarm-/info-LEDs: Load break, thermo couple break, overtemperature, undertemperature, cooling (optionally)

Security-load disconnection:

Mechanical relay opens overtemperature independently

Limit-comparators: +3...99 K, -3...99 K per 1 relay contact switching to N

Thermo couple-input:

Thermoelement according to DIN IEC 584
FE-CuNi Typ J: 0...450 °C

NiCr-Ni Typ K: 0...999 °C

Pt100: 0...450 °C

automatic check of zero point and reverse polarity protection at thermoelement, thermo couple break security function

Cooling output: (optionally)

230 V~/120 VA

Control behaviour: adaptiv, DPID-charakteristik

Accuracy: 0.5 % f.s.

Isolation voltage: 2.5 kV Netz/Elektronik

Dimensions: 50.5 x 128.5 x 195 mm (B x H x T)

Format: 19" / 3HE / 1OTE

Plug: H11 DIN 41612

Weight: 0.8 kg

Blindplates for basic unit Z 7530 GC

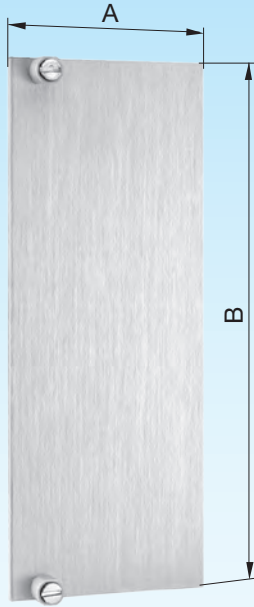



Slots, which are not occupied by controllers or actuators have to be covered by blindplates.



Z 7556 B-

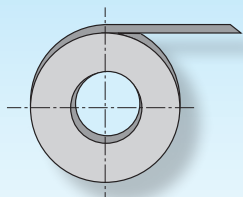

 Z 7556 B-Type



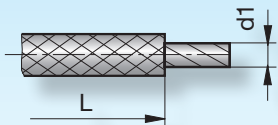



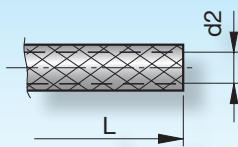





















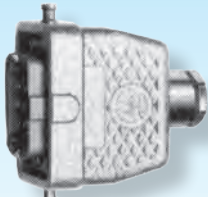

Type	A	B
1	50	128
2	100	128



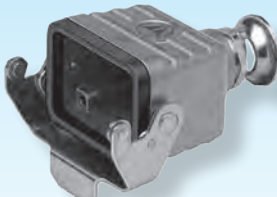









Isolierband	Insulating tape	Ruban isolant								
	Z 7393 max. +150 °C	<table border="1"> <thead> <tr> <th>B (mm)</th> <th>L (m)</th> </tr> </thead> <tbody> <tr> <td>12</td> <td>55</td> </tr> <tr> <td></td> <td></td> </tr> <tr> <td></td> <td></td> </tr> </tbody> </table>	B (mm)	L (m)	12	55				
	B (mm)	L (m)								
12	55									
 Z 7392										









Verlängerungskabel	Extension cable	Cable de prolongement								
	Z 7394- max. +300 °C	<table border="1"> <thead> <tr> <th>d1 (mm)</th> <th>L (m)</th> </tr> </thead> <tbody> <tr> <td>0,75</td> <td>5</td> </tr> <tr> <td>1,5</td> <td>5</td> </tr> <tr> <td></td> <td></td> </tr> </tbody> </table>	d1 (mm)	L (m)	0,75	5	1,5	5		
	d1 (mm)	L (m)								
0,75	5									
1,5	5									
 Z 7394-d1										



Isolierschlauch	Insulating tube	Gaine isolante										
	Z 7395- max. +180 °C	<table border="1"> <thead> <tr> <th>d2 (mm)</th> <th>L (m)</th> </tr> </thead> <tbody> <tr> <td>3</td> <td>5</td> </tr> <tr> <td>4</td> <td>5</td> </tr> <tr> <td>6</td> <td>5</td> </tr> <tr> <td>12</td> <td>5</td> </tr> </tbody> </table>	d2 (mm)	L (m)	3	5	4	5	6	5	12	5
	d2 (mm)	L (m)										
3	5											
4	5											
6	5											
12	5											
 Z 7395-d2												

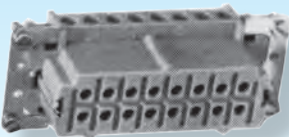

	Z 7395HT- max. +300 °C	<table border="1"> <thead> <tr> <th>d2 (mm)</th> <th>L (m)</th> </tr> </thead> <tbody> <tr> <td>3</td> <td>5</td> </tr> <tr> <td>4</td> <td>5</td> </tr> <tr> <td>6</td> <td>5</td> </tr> </tbody> </table>	d2 (mm)	L (m)	3	5	4	5	6	5
	d2 (mm)	L (m)								
3	5									
4	5									
6	5									
 Z 7395HT-d2										

Gehäuseoberteile	Housing-upper parts	Boîtier multiprises								
	<table border="1"> <tr> <td data-bbox="576 555 794 645">Z 7401-</td> <td data-bbox="799 555 1018 645">16 A</td> </tr> <tr> <td data-bbox="576 651 794 741">  Z 7401-Kontakt </td> <td data-bbox="799 651 1018 741">  </td> </tr> </table>	Z 7401-	16 A	 Z 7401-Kontakt		<table border="1"> <tr> <td data-bbox="1038 555 1476 595">Kontakt / Contacts</td> </tr> <tr> <td data-bbox="1038 602 1476 642">6</td> </tr> <tr> <td data-bbox="1038 647 1476 687"> </td> </tr> <tr> <td data-bbox="1038 694 1476 734"> </td> </tr> </table>	Kontakt / Contacts	6		
Z 7401-	16 A									
 Z 7401-Kontakt										
Kontakt / Contacts										
6										
	<table border="1"> <tr> <td data-bbox="576 1005 794 1095">Z 7402-</td> <td data-bbox="799 1005 1018 1095">16 A</td> </tr> <tr> <td data-bbox="576 1102 794 1191">  Z 7402-Kontakt </td> <td data-bbox="799 1102 1018 1191">  </td> </tr> </table>	Z 7402-	16 A	 Z 7402-Kontakt		<table border="1"> <tr> <td data-bbox="1038 1005 1476 1046">Kontakt / Contacts</td> </tr> <tr> <td data-bbox="1038 1052 1476 1093">6</td> </tr> <tr> <td data-bbox="1038 1097 1476 1137"> </td> </tr> <tr> <td data-bbox="1038 1144 1476 1184"> </td> </tr> </table>	Kontakt / Contacts	6		
Z 7402-	16 A									
 Z 7402-Kontakt										
Kontakt / Contacts										
6										
	<table border="1"> <tr> <td data-bbox="576 1458 794 1547">Z 7403-</td> <td data-bbox="799 1458 1018 1547">16 A</td> </tr> <tr> <td data-bbox="576 1554 794 1644">  Z 7403-Kontakt </td> <td data-bbox="799 1554 1018 1644">  </td> </tr> </table>	Z 7403-	16 A	 Z 7403-Kontakt		<table border="1"> <tr> <td data-bbox="1038 1458 1476 1498">Kontakt / Contacts</td> </tr> <tr> <td data-bbox="1038 1505 1476 1545">6</td> </tr> <tr> <td data-bbox="1038 1550 1476 1590"> </td> </tr> <tr> <td data-bbox="1038 1597 1476 1637"> </td> </tr> </table>	Kontakt / Contacts	6		
Z 7403-	16 A									
 Z 7403-Kontakt										
Kontakt / Contacts										
6										
	<p data-bbox="571 1722 719 1821">ohne Einsatz without inserts sans inserts</p> <table border="1"> <tr> <td data-bbox="576 1910 794 2000">Z 7405-</td> <td data-bbox="799 1910 1018 2000"> </td> </tr> <tr> <td data-bbox="576 2007 794 2096">  Z 7405-Kontakt </td> <td data-bbox="799 2007 1018 2096">  </td> </tr> </table>	Z 7405-		 Z 7405-Kontakt		<table border="1"> <tr> <td data-bbox="1038 1910 1476 1951">Kontakt / Contacts</td> </tr> <tr> <td data-bbox="1038 1957 1476 1998">6</td> </tr> <tr> <td data-bbox="1038 2002 1476 2042"> </td> </tr> <tr> <td data-bbox="1038 2049 1476 2089"> </td> </tr> </table>	Kontakt / Contacts	6		
Z 7405-										
 Z 7405-Kontakt										
Kontakt / Contacts										
6										

Gehäuseoberteile	Housing-upper parts	Boîtier multiprises
	<p>ohne Einsatz without inserts sans inserts</p> <p>Z 7406-</p> <p> Z 7406-Kontakt </p>	<p>Kontakt / Contacts</p> <p>6</p>
	<p>ohne Einsatz without inserts sans inserts</p> <p>Z 7407-</p> <p> Z 7407-Kontakt </p>	<p>Kontakt / Contacts</p> <p>6</p>
	<p>ohne Einsatz without inserts sans inserts</p> <p>Z 7408-</p> <p> Z 7408-Kontakt </p>	<p>Kontakt / Contacts</p> <p>10</p> <p>16</p> <p>24</p>
	<p>Z 7409-</p> <p>16 A</p> <p> Z 7409-Kontakt </p>	<p>Kontakt / Contacts</p> <p>16</p> <p>24</p>

Gehäuseoberteile	Housing-upper parts	Boîtier multiprises					
	<p>ohne Einsatz without inserts sans inserts</p> <p>Z 7410-</p> <p> Z 7410-Kontakt </p>	<table border="1"> <thead> <tr> <th>Kontakt / Contacts</th> </tr> </thead> <tbody> <tr> <td>10</td> </tr> <tr> <td>16</td> </tr> <tr> <td>24</td> </tr> </tbody> </table>	Kontakt / Contacts	10	16	24	
Kontakt / Contacts							
10							
16							
24							
	<p>Z 7411-</p> <p> Z 7411-Kontakt </p>	<table border="1"> <thead> <tr> <th>Kontakt / Contacts</th> </tr> </thead> <tbody> <tr> <td>16</td> </tr> <tr> <td>24</td> </tr> </tbody> </table>	Kontakt / Contacts	16	24		
Kontakt / Contacts							
16							
24							
Buchseinsätze	Bush inserts	Interieur des prises					
	<p>Z 7415-</p> <p>16 A</p> <p> Z 7415-Kontakt </p>	<table border="1"> <thead> <tr> <th>Kontakt / Contacts</th> </tr> </thead> <tbody> <tr> <td>6</td> </tr> <tr> <td>10</td> </tr> <tr> <td>16</td> </tr> <tr> <td>24</td> </tr> </tbody> </table>	Kontakt / Contacts	6	10	16	24
Kontakt / Contacts							
6							
10							
16							
24							

Steckereinsätze	Connection inserts	Interieur des connecteurs					
	Z 7416-	16 A					
	 Z 7416-Kontakt						
		<table border="1"> <thead> <tr> <th>Kontakt / Contacts</th> </tr> </thead> <tbody> <tr> <td>6</td> </tr> <tr> <td>10</td> </tr> <tr> <td>16</td> </tr> <tr> <td>24</td> </tr> </tbody> </table>	Kontakt / Contacts	6	10	16	24
Kontakt / Contacts							
6							
10							
16							
24							

Verbindungskabel	Connecting cables	Cables de raccordement						
	halogenfrei without halogen sans halogène							
	Z 7419 H-	16 A max. +90 °C						
 Z 7419H-Kontakt-L		<table border="1"> <thead> <tr> <th>Kontakt / Contacts</th> <th>L (m)</th> </tr> </thead> <tbody> <tr> <td>6</td> <td>3</td> </tr> <tr> <td>6</td> <td>6</td> </tr> </tbody> </table>	Kontakt / Contacts	L (m)	6	3	6	6
Kontakt / Contacts	L (m)							
6	3							
6	6							

	halogenfrei without halogen sans halogène															
	Z 7421 H-	16 A max. +90 °C														
 Z 7421H-Kontakt-L		<table border="1"> <thead> <tr> <th>Kontakt / Contacts</th> <th>L (m)</th> </tr> </thead> <tbody> <tr> <td>10</td> <td>3</td> </tr> <tr> <td>10</td> <td>6</td> </tr> <tr> <td>16</td> <td>3</td> </tr> <tr> <td>16</td> <td>6</td> </tr> <tr> <td>24</td> <td>3</td> </tr> <tr> <td>24</td> <td>6</td> </tr> </tbody> </table>	Kontakt / Contacts	L (m)	10	3	10	6	16	3	16	6	24	3	24	6
Kontakt / Contacts	L (m)															
10	3															
10	6															
16	3															
16	6															
24	3															
24	6															

Flanschgehäuse

Flanged housings

Boîtier multiprises

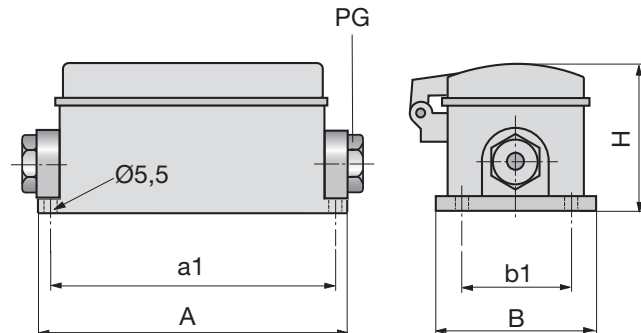
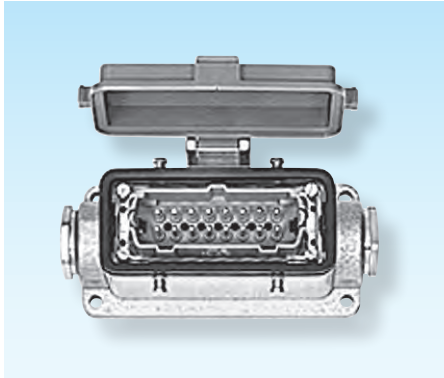

Z 7423-

16 A

Type	Kontakt / Contacts	A	B	a1	b1	H
1	6	85	52	70	40	70
2	16	117	57	105	45	78
3	24	145	57	132	45	79
15	10	93	52	82	40	74

 Z 7423-Type

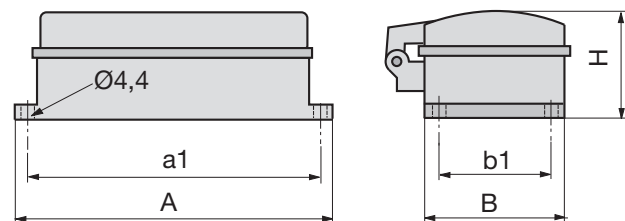
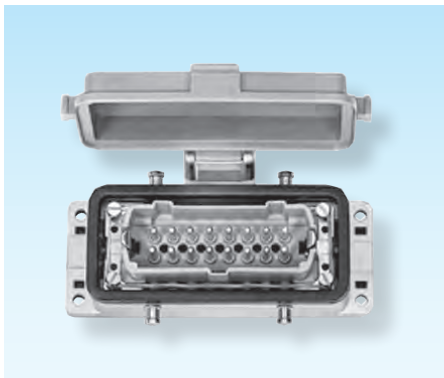

Z 7424-

16 A

Type	Kontakt / Contacts	A	B	a1	b1	H
1	6	81	45	70	32	46
2	16	114	45	103	32	46
3	24	141	45	130	32	46
15	10	95	45	83	32	46

 Z 7424-Type



Flanschgehäuse

Flanged housings

Boîtiers multiprises

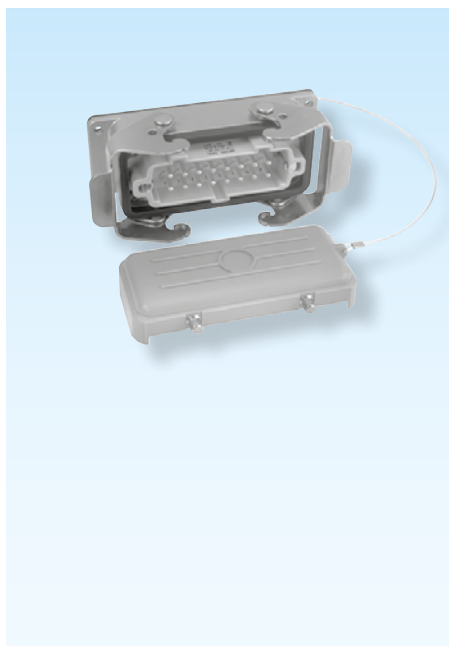

Type 1

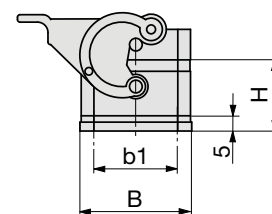
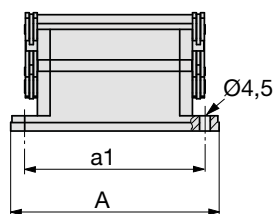

Type 2, 3, 4

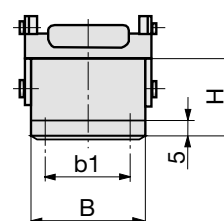
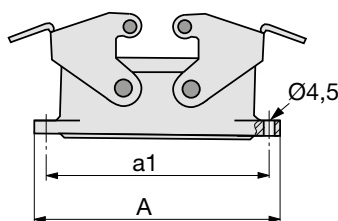

Z 7425-

16 A



Z 7425-Type



Type	Kontakt / Contacts	A	B	a1	b1	H
1	6	81	43	70	32	45
2	10	93	43	83	32	45
3	16	114	43	103	32	46
4	24	140	43	130	32	46



ohne Einsatz
without inserts
sans inserts

Type 1

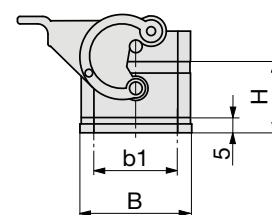
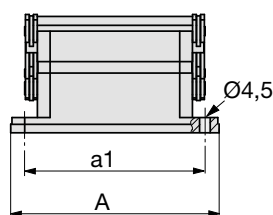

Type 2, 3, 4

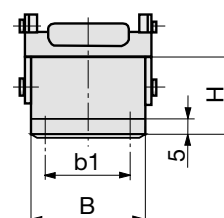
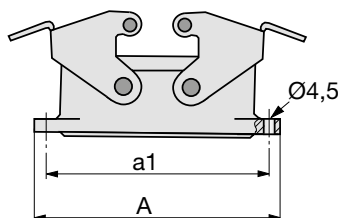

Z 7427-

16 A



Z 7427-Type



Type	Kontakt / Contacts	A	B	a1	b1	H
1	(6)	81	43	70	32	45
2	(10)	93	43	83	32	45
3	(16)	114	43	103	32	46
4	(24)	140	43	130	32	46

Anschlussboxen

Connection boxes

Boîtiers de raccordement

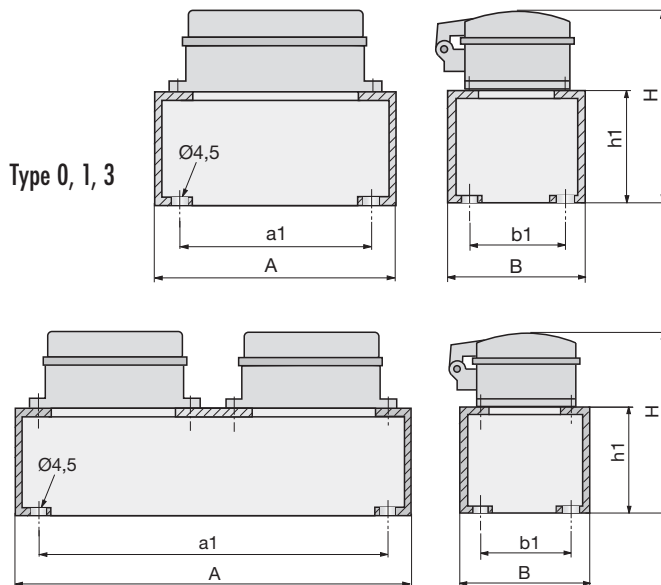
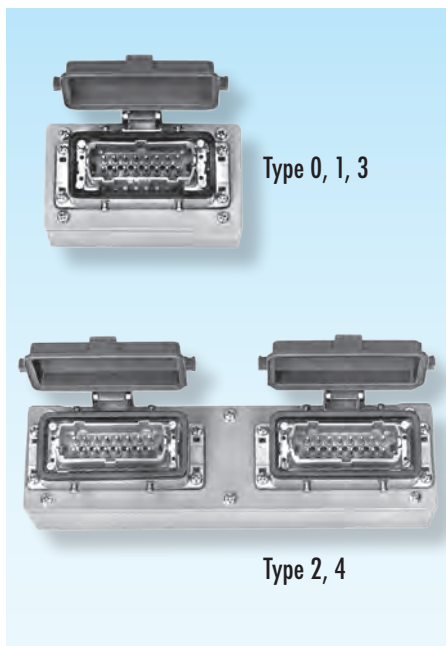

Z 7429-

16 A



Z 7429-Type



Type	Kontakt/Contacts	A	B	a1	b1	H	h1
0	1 x 10	95	72	70	56	95	52
1	1 x 16	128	72	103	56	95	52
3	1 x 24	155	72	130	56	95	52
2	2 x 16	280	72	250	56	95	52
4	2 x 24	322	73	302	56	95	52

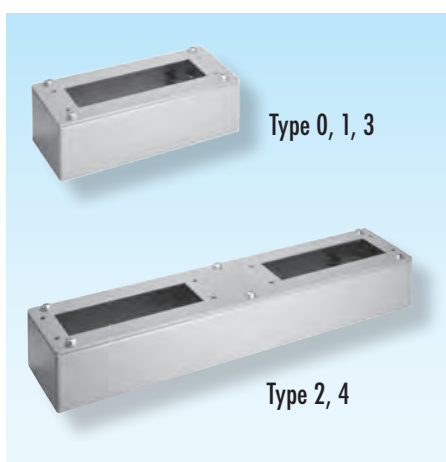

ohne Einsatz
without inserts
sans inserts

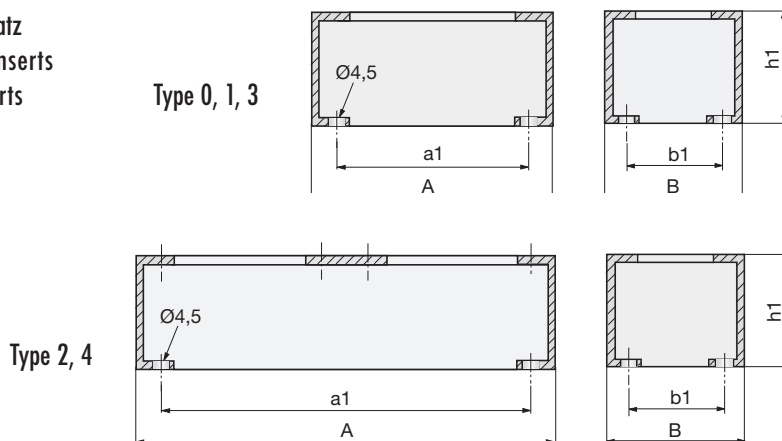

Z 7429L-



Z 7429L-Type



Type	A	B	a1	b1	h1
0	95	72	70	56	52
1	128	72	103	56	52
3	155	72	130	56	52
2	280	72	250	56	52
4	322	73	302	56	52

Distanzrahmen

Distance frame

Cadre dedistance

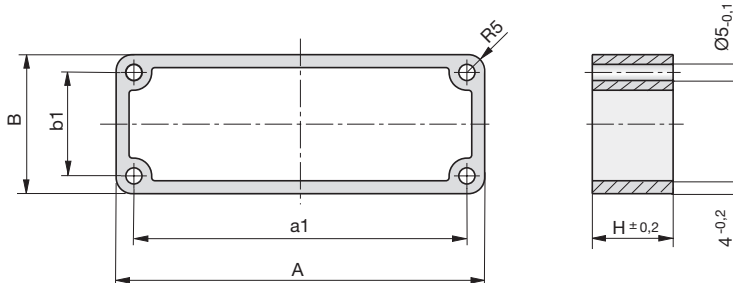
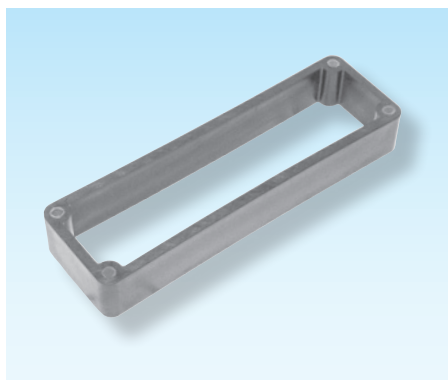

Z7433-

Mat.: PBT 30% GF
max. 120 °C

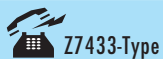

Z7433-Type



Type	A	B	a1	b1	H
1	81	43	70	32	25
2	93	43	83	32	25
3	114	43	103	32	25
4	140	43	130	32	25
5	81	30	70	17,5	25
6	96	30	86	17,5	25

Z7424 -		Z7425 -		Z7427 -	
Type	Kontakt /Contacts	Type	Kontakt /Contacts	Type	Kontakt /Contacts
1	6	1	6	1	6
2	16	2	10	2	10
3	24	3	16	3	16
		4	24	4	24

Z7424 -, Z7425 -, Z7427 -

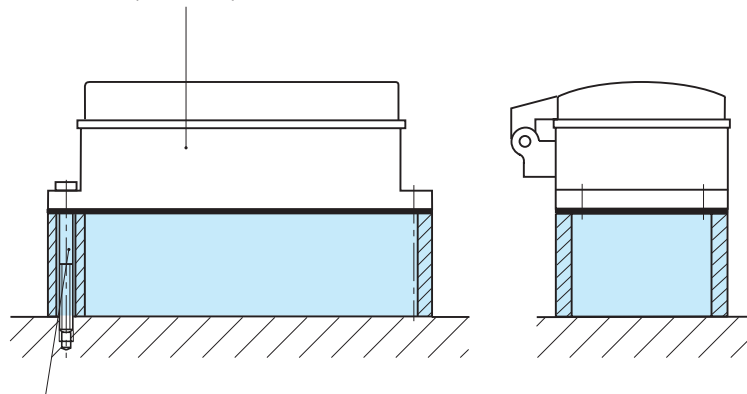

SN3500-4-40

Mini-Flanschgehäuse

Mini flanged housing

Mini-boîtier de connexion

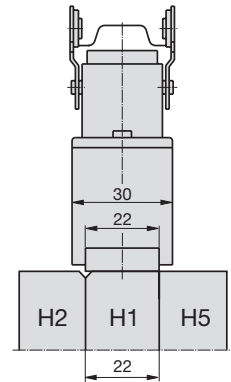
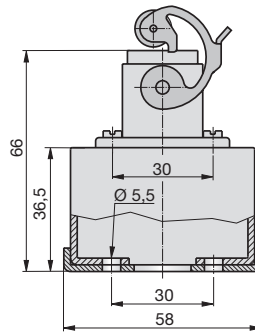
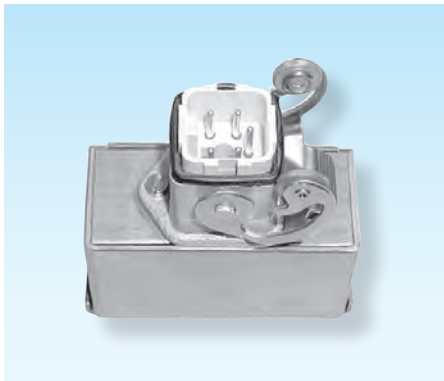

Z 7440-

10 A
max. +90 °C



Type

1

2

Kontakt / Contacts

4 (5)

6 (7)

Flanschgehäuse

Flanged housing

Boîtier de connexion

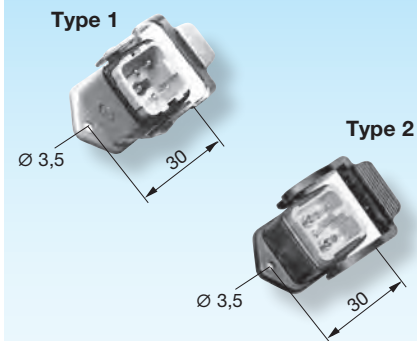

Z 7442-

10 A
max. +90 °C



Type

1

2

Kontakt / Contacts

4 (5)

6 (7)

Steckereinsätze

Connection inserts

Interieur des prises



Z 7443-

10 A
max. +90 °C



Type

1

2

Kontakt / Contacts

4 (5)

6 (7)

Verbindungskabel	Connecting cables	Cables de raccordement
------------------	-------------------	------------------------



Z 7444H-	10 A max. +90 °C
Z 7444H- Kontakt-L	

Kontakt / Contacts	L (mm)
4 (5)	3000
4 (5)	6000
6 (7)	3000
6 (7)	6000

Gehäuseoberteile	Housing-upper parts	Boîtier multiprises
------------------	---------------------	---------------------



Z 7445-	10 A max. +90 °C
Z 7445-Kontakt	

Kontakt / Contacts
4 (5)
6 (7)

Buchseneinsätze	Bush inserts	Interieur des prises
-----------------	--------------	----------------------

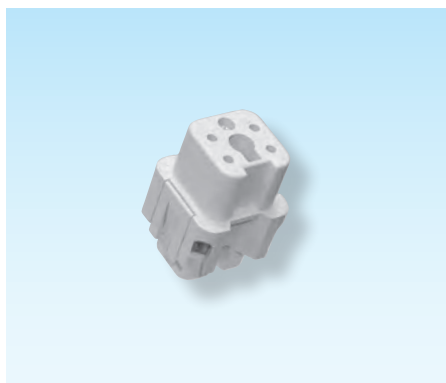

Z 7446-	10 A max. +90 °C
Z 7446-Kontakt	

Kontakt / Contacts
4 (5)
6 (7)

Heißkanalsysteme

Nutzen Sie die Vorteile unseres Heißkanalsystems:

- Effiziente Zykluszeiten
- Verbesserte Qualität und Gleichmäßigkeit der Formteile
- Minimale Anschnittmarkierung
- Reduzierter Einspritzdruck
- Nadelverschlüsse ermöglichen eine sequenzielle Anspritzung und Familienwerkzeuge

Bitte fordern Sie unseren Katalog an!

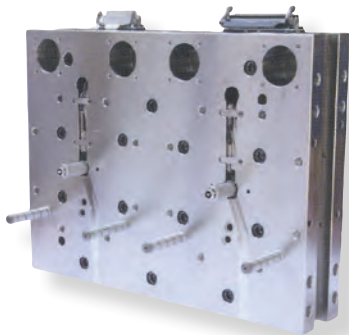
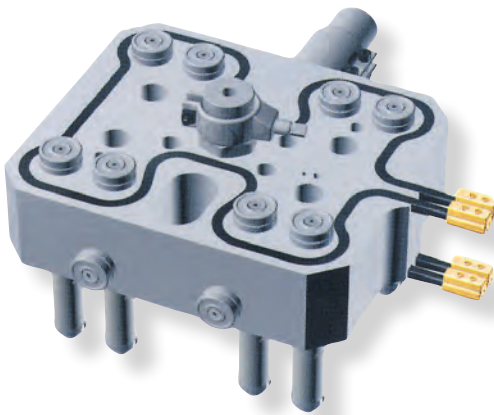

Use the advantages of our hot runner systems:

- Efficient cycle times
- Improved quality and uniformity of the moulded parts
- Minimal gate vestige
- Reduced injection pressure
- Needle shut-offs allow a sequential gating and family moulds

Please ask for our brochure!

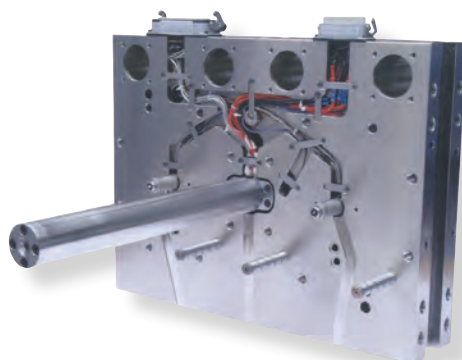

Systèmes à canaux chauds

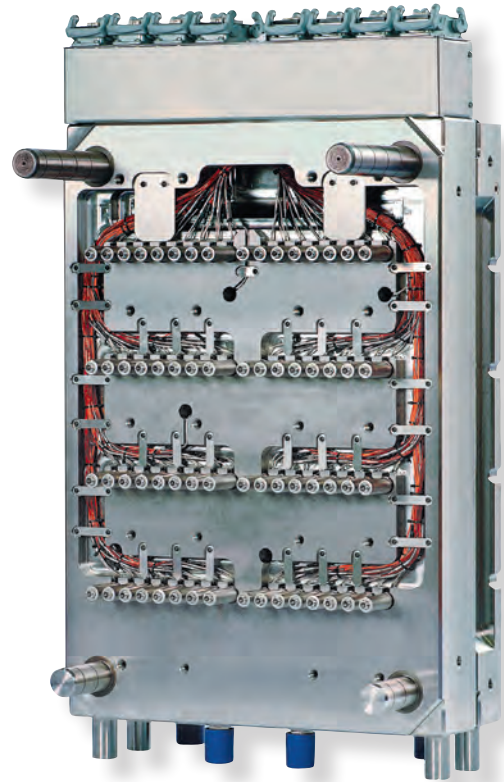

Utilisez les avantages des nos systèmes à canaux chauds:

- Temps de cycle efficients
- Qualité et uniformité améliorée des pièces moulées
- Points d'injection quasi invisibles
- Pression d'injection réduite
- Fermetures par aiguilles permettent une injection séquentielle et des moules familiales

Veillez demander notre prospectus!

